

# User Guide

## Sauna heater Pikkutonttu Digital control panel Digi 2002

User Guide for the following  
models of the sauna heater Pikkutonttu:

1116-45-0405 (4,5 kW)

1116-65-0405 (6,5 kW)

1116-90-0405 (9,0 kW)

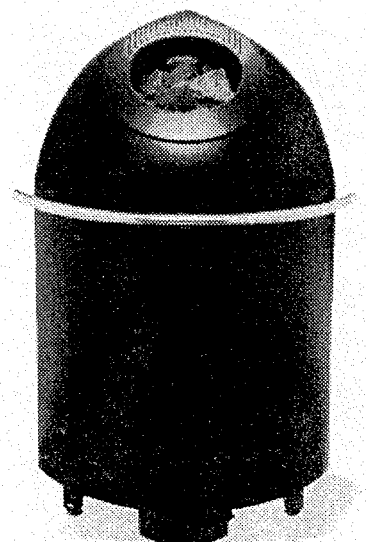

**helo**

---

# **Thank you for choosing quality products from Helo Ltd**

We think that our products will live up to your expectations and give you many hours of enjoyment in your sauna. We want you, your family and your friends to have many comfortable sauna baths and at the same time find new ways to enjoy sauna bathing. We have taken today's demands on sauna bathing into consideration and equipped the sauna heater with many usable and unique functions. Among other things, the control panel has four memory buttons, which can be pre-programmed to your personal favorite sauna bath. Read this manual carefully. The manual is divided into two separate sections. The first is for you as a user and the second is for the installer.

Helo Ltd is the world-leading producer of products for saunas and steam saunas. We develop, produce and market products for saunas and steam saunas in the whole world. Helo has the largest factories of sauna products in the world (Finland, Germany and USA) and a well-developed net of retailers, both nationally and internationally. Our product range consists of sauna- and steam rooms, electric and wood heaters, control panels and sauna accessories.

# Information to the user

This user guide helps you to understand and use your new sauna products. We hope that you read this manual carefully and that you respect the warning texts.

The user guide is divided into two sections: **Information to the user** and **Information to the installer**. You, as a user, receive a thorough description of the workings of a sauna heater, how to use the control panel and what you should keep in mind regarding maintenance.

If you have questions or if you need help with the products, please turn to your local retailer.

Certain portions of the user guide are more important than others. At these portions we use the following symbols:



**Warning**



**Observe**



**Tips and advice**

## Table of contents for the user

This is how a sauna works .....	4
The sauna heater and included parts .....	5
The control panel and included parts .....	6

### Functions of the control panel

- Set the time and chose the language .....	8
- Set the start time .....	9
- Set the temperature .....	10
- Set the duration .....	10
- Program and activate the memory buttons .....	11
- Change the settings during the sauna bath .....	12
- Calibrate the temperature .....	13
- Activate Smartsauna .....	13
- Lock the control panel .....	14
- Lock fan or lighting .....	14
Alarm .....	15
Maintenance .....	15
General information about sauna bathing .....	16
Examples of different sauna baths .....	16
Recommended ventilation .....	17
Information to the installer .....	19-29

# This is how a sauna works

A sauna works in the same fashion as a room in a house. In the room there are heating elements that make sure that the room temperature is maintained at the desired temperature. Ventilation lets fresh air in and spent air is led out. A sauna works in the same way. However, there are a few parameters that must be correct for a sauna to function optimally. The most important relationship is between the output of the heater and the volume of the sauna room. If the dimensions are incorrect, it can cause the sauna to heat up too quickly or the heater to overload.

## Heating elements and stones

In the heater there are stainless steel elements which radiate heat. The heat is transmitted to stones that are placed in the heater. These stones help to keep an even temperature in the sauna. The stone compartment should be airy. The larger stones are placed on the bottom and the smaller stones on top. The stones should cover the heating elements completely. After some time of usage it may appear that the amount of stones has diminished. What happens is that the stones crack and then pack tighter together. This causes the air circulation in the heater to be reduced, and it takes longer time to heat up. There is a rule of thumb that is good to follow when it comes to taking care of the stones in the heater. The rule of thumb says that if you use your sauna once a week you need to repack the stones once a year. Twice a week means repacking twice a year and so on. Replace those stones that have become brown or black from the heat. We recommend that you brush and rinse the sauna stones free from grit before they are placed in the heater.

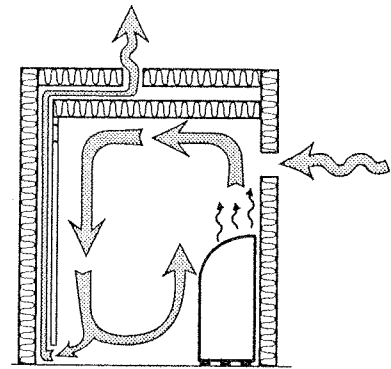

*Example of the correct ventilation in the sauna. Read more about ventilation on page 17.*

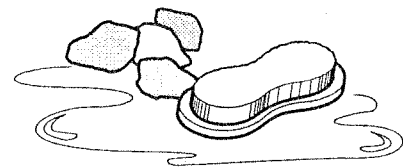

*Brush off the sauna stones from grit before you place them in the heater.*

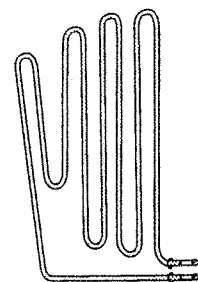

The heating elements heat the stones in the sauna heater.

# The sauna heater and included parts

## Sauna heater

The sauna heater Pikkutonttu is, with its design and technology, a heater that offers unique qualities. The low temperature of the mantle results in a safety distance between the mantle and the closest wood part of only 10 mm. You can begin ladling water on the heater at such low temperatures as 50–60° C. The sauna heater should be filled with about 80 kilograms of rocks.

## Temperature sensor

The temperature sensor is mounted inside the sauna. It is mounted by an installer directly over the heater, 40 mm from the ceiling. The sensor has two functions:

1. Register the temperature in the sauna and send signals to the heater for more or less output.
2. Protection against overheating. In the event of overheating, the heater is turned off if the temperature in the sauna gets to high (see Alarm on page 15). Deviations from the given distances cause fire hazard. The function of the sensor is to turn off the entire output of the heater if the temperature of the heater gets too high. When the temperature has sunk, the sensor can be reset by pushing the reset button with a screwdriver. Before you reset the sensor the cause of the fault shall be corrected.

## Digital control panel

With the help of a control panel, the user sets temperature, start time and duration. The control panel is mounted on the wall by an installer. It can be mounted in two ways: inserted in the wall or mounted on the wall. The programming of the time and language is easily done by you or the installer. See more information about the control panel on page 6.

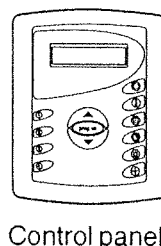
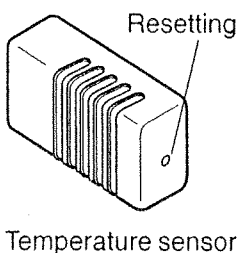
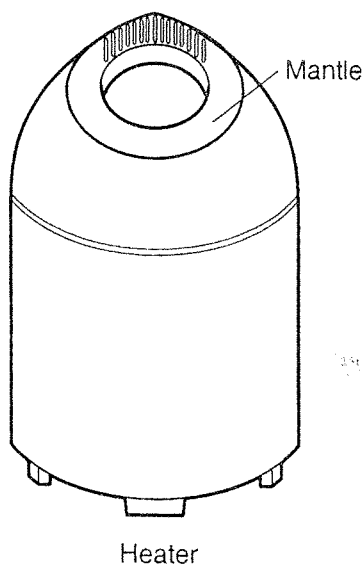

## Facts about the sauna heater

Model	4	6	9
Output (kW)	4.5	6.6	9
Sauna volume (m <sup>3</sup> )	3-6	5-10	9-14
Safety distance (mm)	10	10	10
Weight (kg)	33	33	33
Amount of stones (kg)	80	80	80
Size depth x height (mm)	460x990		

See Parts included in the delivery on page 21.

# The control panel and included parts

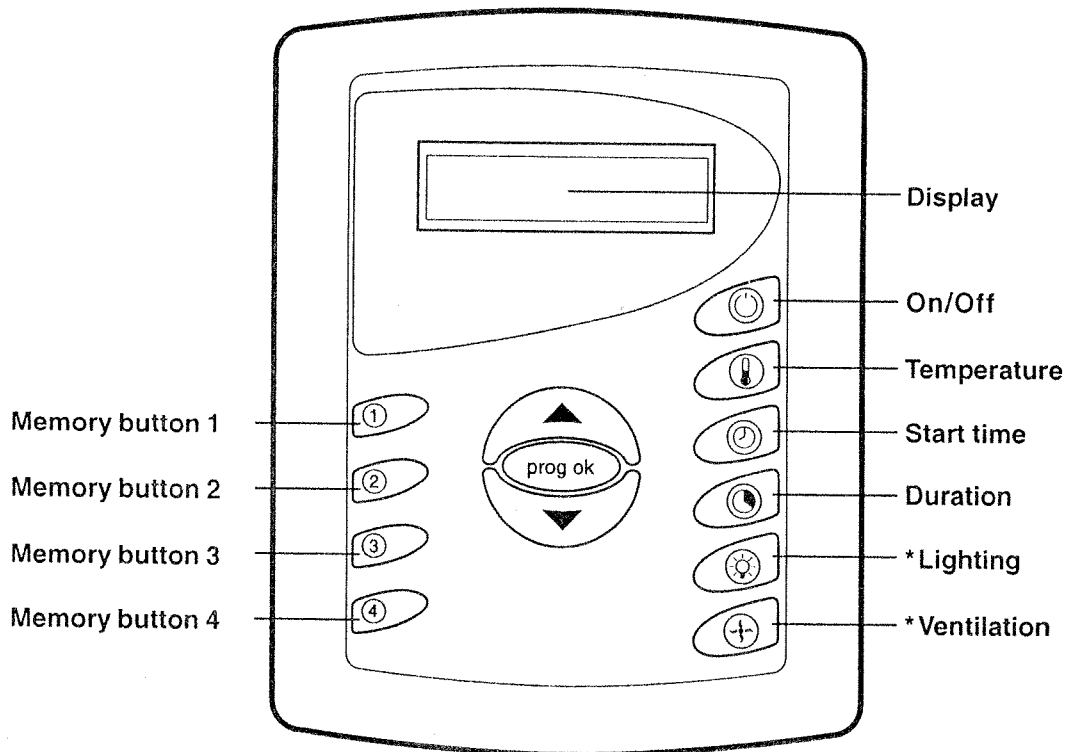

## The button prog ok

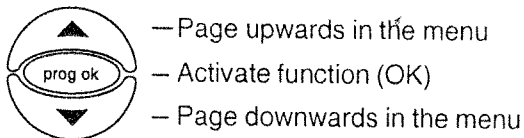

## The display



## Observe

\* If lighting and ventilation have been connected to the control panel, you can activate them with the appropriate buttons. If they are not connected, contact your retailer or a certified electrician.

You access the settings of the control panel (clock and language) by pushing the button **prog ok** for three seconds when the panel is not on.



## Tips and advice

The control panel gives you the opportunity to set four separate sauna baths. We recommend that you utilize the useful function of the memory buttons. Read more on page 11.

# Functions of the control panel

With the control panel, you set the time for the heater to start, for how long it will work and the temperature in the sauna. It is also possible to program four memory buttons for special sauna baths. This means that you only need to push one button to start the heater.

To start the sauna heater, you need to adjust the following parameters:

-  1. Start time – when the heater is to start.
-  2. Temperature – the temperature in the sauna.
-  3. Duration – the length of time the heater is to be on.

## Memory buttons:

We recommend that you take advantage of the memory buttons when using your sauna. You can easily enter your preferences on separate buttons. When it is time to take a sauna bath you activate them with a single push. Each memory button has preset values when the control panel is delivered from the factory. Read more about memory buttons on page 11.

## Basic settings:

Before you use the sauna, you need to set the basic settings on the control panel. These basic settings are setting the time and choosing the language. Read more about basic settings on page 8.

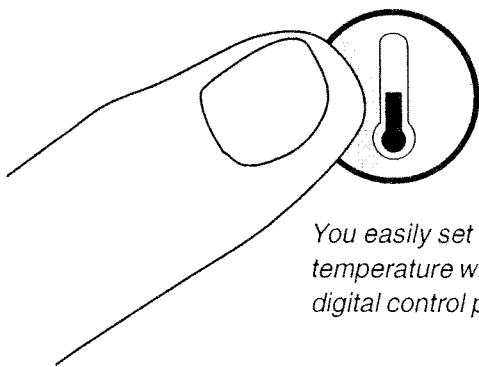

*You easily set the temperature with the digital control panel.*

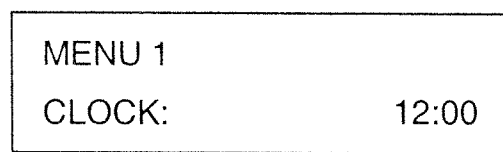

*You set the time by programming in the menu-mode. See more information on page 8.*

# Set the time and chose the language

The control panel returns automatically to the off-mode from the menu-mode if you do not push a button within three seconds. If a change is done it must be approved with the **prog ok** button before the control panel resumes off-mode, otherwise the change is not saved.

## Set the time

*Make sure that the control panel is in off-mode before you set the time*

1. Push the button **prog ok** for three seconds

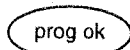

*The display shows:*

MENU 1	
CLOCK:	12:08

2. Set the time with the arrow buttons



3. Approve the new time with the button **prog ok**

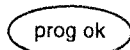

## Chose language

*Make sure that the control panel is in off-mode before you chose language.*

1. Push the button **prog ok** for three seconds

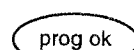

2. Page to Menu 2 by pushing the button **prog ok**

*The display shows:*

MENU 2	
LANGUAGE:	ENGLISH

3. Chose the new language with the arrow buttons



4. Approve the new language with the button **prog ok**

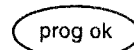

### Observe

If there is a power failure of more than 20 minutes, the time is deleted from the control panel. Then you have to reprogram the setting.

The control panel has five languages to chose from: Finnish, English, Swedish, German and Dutch.



# Set start time, temperature and duration

1

## Set the start time

The start time is the time that the heater turns on, for example 18:30.

1. Start the panel with the **On/Off** button



The background lighting is lighted

2. Push the button **prog ok**

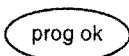

The display shows earlier chosen settings, for example:

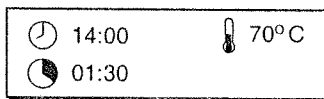

3. Push the button for start time



The display shows:

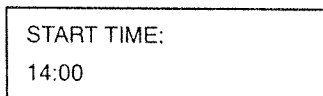

4. Set start time, for example 18:30, with the arrow buttons



5. Approve the start time with the button **prog ok**

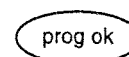

The display shows:

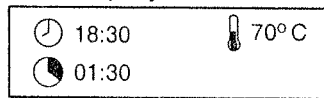

6. Start the heater by pushing **prog ok** for three seconds.

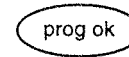

## Tips and advice

By holding the arrow button depressed the values are paged up or down fast.

## 2

### Set the temperature

The temperature is the temperature that the heater produces in the sauna, for example 80° C.

1. Push the button for the temperature 



The display shows:

TEMPERATURE:  
70° C

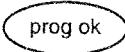
2. Set the temperature with the arrow buttons, for example 80° C 

3. Approve the temperature with the button **prog ok** 

The display shows:

 18:30  80° C  
 01:30

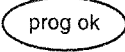
4. Start the heater by pushing **prog ok** for three seconds. 

## 3

### Set the duration

Duration is the time that the heater will operate. Maximum duration is six hours.

1. Push the button for start time 



The display shows:

ON-TIME:  
01:30

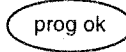
2. Enter duration with the arrow buttons, for example 30 minutes 

3. Approve the duration with the button **prog ok** 

The display shows:

 18:30  80° C  
 01:30

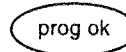
4. Start the heater by pushing **prog ok** for three seconds. 

### Turn on the lightning

1. Push the button for lighting 

The display shows:



### Activate ventilation

1. Push the button for ventilation 

The display shows:



# Program and activate the memory buttons

The digital control panel has four memory buttons. As a user you have the opportunity to set four separate sauna bath programs. Each program has its own adjustments, and you activate them with just a push of a button.

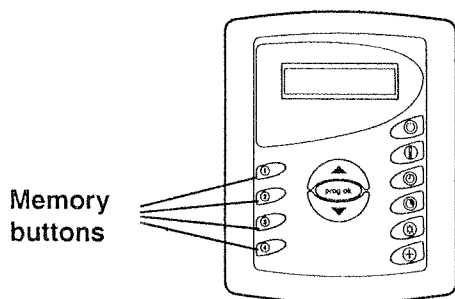

When the control panel is delivered from the factory the memory buttons are pre-set. It is a good idea, however, to change the settings so that you get the sauna bath of your choice. Set the temperature and duration of the sauna heater according to earlier instructions (see page 10).

**The preset values of the memory buttons are:**

■ Duration:	Two hours
■ Temperature:	Button 1: 60° C
	Button 2: 70° C
	Button 3: 80° C
	Button 4: 90° C

## Program a memory button

1. Enter a duration on the control panel
2. Enter a temperature on the control panel
3. Push one of the memory buttons
4. Push the button **prog ok**

## Activate a memory button

1. Start the control panel with the **On/Off** button
2. Push one of the memory buttons



## Check a memory button

1. Make sure that the control panel is in Off-mode. The display is not lighted.
2. Push a memory button and read the settings. The display is lighted.

# Change the settings during the sauna bath

The instructions below show how to change the settings during the sauna bath. You may want to lower the temperature or shorten the duration.

## Change the temperature

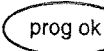

1. Push the button for temperature 
2. Set the new temperature with the arrow buttons 
3. Approve the new temperature with the button **prog ok** 

## Turn off the sauna

1. Push the **On/Off** button   
The display shows:

14:00

## Change the duration

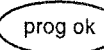
1. Push the button for duration 
2. Set the new duration with the arrow buttons 
3. Approve the new duration with the button **prog ok** 



## Observe

To change the settings during the sauna bath does not change the values in the memory buttons. The change only affects the ongoing sauna bath.

# Calibrate the temperature

If you have a thermometer inside the sauna that does not show the same temperature as that which has been entered on the control panel, you can make a calibration (Offset). This means that you adjust the control panel and the thermometer after the same scale. That the temperatures differ is due to the fact that the warmth in the sauna is not exactly the same in all spaces.

## Example:

Your thermometer inside the sauna shows 84°C and your control panel is set on 80°C. The difference is thus + 4°C. By setting OFFSET: T1 on - 4°C, the control panel will show the right temperature.

### Calibrate the temperature

*Make sure that the control panel is in Off-mode before you calibrate the temperature.*

1. Push the button **prog ok** for three seconds
2. Page to the menu 3 with the button **prog ok**
3. Calibrate the temperature with the arrow buttons
4. Approve the temperature with the button **prog ok**

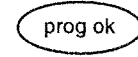
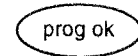
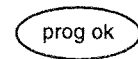

# Activate Smartsauna

Smartsauna is a function that measures the temperature in the sauna and computes the length of time the heater will take to heat the sauna to the temperature that is set on the control panel. The function only works when it is activated and in conjunction with a time setting.

## Example:

You have had a hard day at work and wish to relax with a sauna bath directly when you come home. When you arrive home at 16:00, you want the sauna to be ready for you. By activating the function Smartsauna the control panel computes when the heater should start, in order to warm up the sauna to the temperature you have chosen on the control panel.

### Activate Smartsauna

*Make sure that the control panel is in Off-mode before you activate Smartsauna.*

1. Push the button **prog ok** for three seconds
2. Page to the menu 4 with the button **prog ok**
3. Chose Smartsauna ON with the arrow buttons
4. Approve the activation with the button **prog ok**

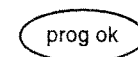
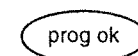
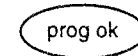

## Lock the control panel

When a control panel is locked it is not possible to start the heater. This might be suitable in situations where you wish to have control of the sauna, for example when children are playing in the vicinity and you want to hinder that the heater is turned on by mistake.

### Lock the control panel

*Make sure that the control panel is in Off-mode before you lock the control panel.*

1. Push the up arrow
2. Push the down arrow
3. Push the fan button



*The display show: LOCKED*

*Remove the lock with the same combination.*

## Lock the fan or lighting

When the fan or lighting is locked, it is impossible to cut off the ventilation or turn off the light in the sauna. The light cannot be turned off and the ventilation cannot be cut off before the lock has been removed.

### Lock the fan or light

*Make sure that the control panel is in Off-mode before you lock the fan or lighting.*

1. Push the fan button or the lighting button
2. Push the up arrow
3. Push the down arrow
4. Push the fan button

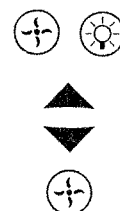

*The display show: LOCKED*

*Remove the lock with the same combination.*



### Observe

Do not pause more than one second when pushing the buttons, as you are activating or deactivating the locks.

# Alarm

When there is an alarm situation, the control panel stops the heating, and the cause for the alarm is shown on the display of the control panel.

Alarm	Display	What to do
The cable of the temperature sensor is broken.	ALARM T1 CABLE OFF	Check the cable to and from the sensor.
The temperature sensor is triggered.	ALARM CLEAR T1	Check the cause. Reset the sensor by pushing the reset button with a screwdriver.

# Maintenance

## Sauna stones

We recommend that you brush and rinse the sauna stones free from grit before placing them in the stone compartment. If the stones begin to crumble, you should replace them as soon as possible. Read more about sauna stones on page 4.

## The sauna

The sauna should be kept free of dirt and odors, just like the bathroom. Remove any accumulations of water and salt with the help of soft soap and water. Furthermore, be careful not to keep laundry and other fire hazardous material close to the heater.

## Vent

In the sauna there is a vent (outlet vent) that releases warm air. Clean the outlet vent with water and soft soap once or twice a year.

# General information about sauna bathing

- Allow yourself plenty of time when you take a sauna bath. You should not feel stressed. To take a sauna bath should be a pleasure.
- Take a shower before entering the sauna. If the situation demands that you wear a towel, it should not be too tight.
- Take a break after 10–15 minutes. Leave the sauna, enjoy a cold shower and relax. Repeat this procedure as you see fit.
- Many feel that the most pleasurable part of sauna bathing is “throwing water” on the hot stones of the heater, which means that a few scoops of water are ladled over the hot stones. The cloud of hot air that is formed is called “löyly” and is considered the soul of the sauna.

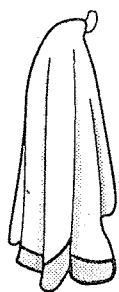

Use a towel if the situation calls for it.



Take a shower before entering the sauna.

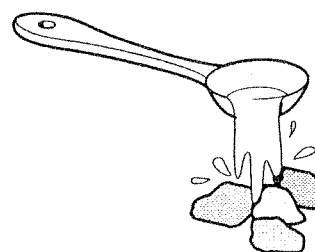

Increase the moisture by ladling water on the stones.

## Examples of different baths

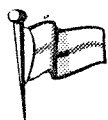

### Finnish sauna

A Finnish sauna is humid and has a high temperature. This is achieved by ladling water on the stones. The effect of a Finnish sauna is that you feel clean and warm. To achieve this:

1. Set the temperature between 70 and 80°C
2. Ladle water on the stones until the humidity is ca 20 %.
3. Take a sauna bath for 10–15 minutes.
4. Take a break of about 5 minutes. Cool down and drink fluids.
5. Repeat this procedure as many times as you like.





## **Wet sauna**

A wet sauna means high humidity and low temperature. This is achieved by ladling water on the stones. The effect of a wet sauna is that you feel clean. To achieve this:

- 1. Set the temperature at about 60°C*
- 2. Ladle water until the humidity is ca 40 %.*
- 3. Take a sauna bath for 15–20 minutes before you take a break. Drink fluids.*
- 4. Repeat this procedure as many times as you like.*



## **Dry sauna**

A dry sauna has high temperature and low humidity. This is achieved by not ladling water on the stones. The effect of a dry sauna is that you feel calm and harmonious. To achieve this:

- 1. Set the temperature between 85 and 90°C. Humidity 5–10 %.*
- 2. Take a sauna bath for 15–20 minutes.*
- 4. Take a break of about 5 minutes. Cool down and drink fluids.*
- 5. Repeat this procedure as many times as you like.*

Recommended sauna room ventilation

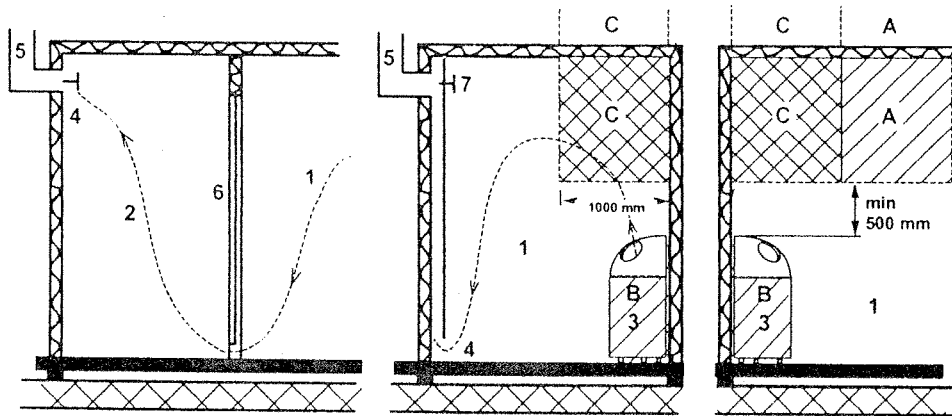

- |  |                          |                            |
|--|--------------------------|----------------------------|
| 1. Sauna room  | 3. Electric sauna heater | 5. Exhaust flue or channel |
| 2. Washroom  | 4. Exhaust valve         | 6. Door to the sauna room  |
| 7. A ventilation valve can be installed here to be kept closed while the sauna is heated and during bathing. |                          |                            |

Inlet vent can be positioned in the A zone. Make sure the incoming fresh air will not interfere with (i.e. cool down) the sauna heater's thermostat near the ceiling.

The B zone serves as the incoming air zone, if the sauna room isn't fitted with forced ventilation. In this case, the exhaust valve is installed min 1m higher than the inlet valve.

**DO NOT INSTALL INLET VALVE WITHIN ZONE C, IF THE SAUNA HEATER'S CONTROL THERMOSTAT IS LOCATED AT THE SAME ZONE.**

# Information to the installer

This user guide gives you answers to how to install electrical cables and the control panel in the user's sauna. We want you to read the ENTIRE user guide, that is both sections: **Information to the user** and **Information to the installer**. We feel that even an installer benefits from the information directed to the user. Be sure to read all the Observe- and Warning-panels.

The user guide applies to the following heater models:

1116-45-0405 (4.5 kW)

1116-65-0405 (6.5 kW)

1116-90-0405 (9.0 kW)

Some portions of the user guide are more important than others. At these portions we use the following symbols:



**Warning**



**Observe**



**Tips och advice**

## Table of content for the installer

Information to the user .....	3-18
Important information to the installer .....	20
Check list .....	20
Parts included in the delivery .....	21
Mount the heater and temperature sensor .....	22
Connect the electricity .....	26
Mount and program the control panel .....	28
Test the sauna and take safety measurements .....	29

# Important information to the installer

This user guide is an important tool for you who will mount and install the sauna heater Pikkutonttu. There are several installation dimensions that must be followed exactly due to safety requirements. If you have any questions during the installation we recommend you to turn to your retailer.

When the mounting and installation are completed, we would like you to give this user guide to the user. Do not throw it away but make sure that the user gets the user guide in order to be able to handle the digital control panel. Use the checklist to be sure that all the steps in the installation process have been completed.



## Observe!

- Follow the installation dimensions given in this user guide.
- Only one heater may be installed in the sauna room.
- A certified electrician, in accordance with the valid regulations, must do all the electrical connections.
- If you have questions or need help with the installation, turn to your local retailer.

## Check list

1. Read this user guide carefully
2. Check that all the parts are delivered
3. Mount the temperature sensor in the sauna
4. Mount the control panel in or on the surface of the wall
5. Connect the electrical cables to the heater
6. Mount the heater in the sauna
7. Program the basic settings in the control panel
8. Test heat the sauna and make the necessary safety measurements
9. Give this user guide to the user after finishing the installation



## Observe!

Before you start the heater with the control panel, make sure that you have gone through all the steps in the check list and that the sauna is ready to be used.

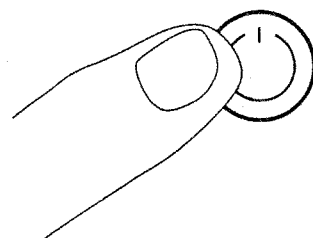

# Parts included in the delivery

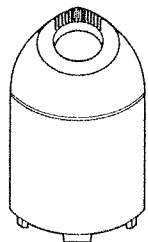

**Sauna Heater Pikkutonttu**

1 pc

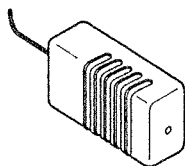

**Temperature sensor with cord**

1 pc

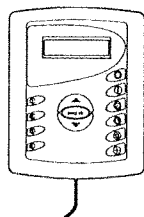

**Digital control panel Digi 2002 with cord**

1 pc



**Control panel opener**

2 pcs



**User Guide**

1 pc

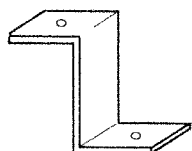

**Bracket**

2 pcs



**Bracket-screw, 4,2 x 16 mm**

2 pcs



**Bracket-screw, 4,2 x 9,5 mm**

2 pcs



**Sheet-metal screw for the control panel, 2 x 20 mm**

2 pcs



**Sheet-metal screw for the control panel, 4,2 x 13 mm**

3 pcs



## **Observe!**

If any of the parts are missing in delivery, you should contact your retailer.

# Mount the heater and temperature sensor

To mount the heater requires thoroughness by the installer. The different models of sauna heaters have their own specific installation dimensions, and these must be followed exactly due to safety reasons.

There are three separate ways to mount the heater in the sauna: **wall mounting**, **corner mounting** and **floor mounting**. In the following pages you will find sketches for the placement of the heater in the sauna room and which choices there are to mount the temperature sensor. The installation dimensions are exact – they cannot be deviated from. Observe that you should not mount the heater until you have connected all the cables.

## Mount the heater:

There are three separate ways to mount the heater:

1. *Wall mounting*
2. *Corner mounting*
3. *Floor mounting*

### Follow these instructions:

1. Study the installation dimensions in the pictures and the table on pages 23–24.
2. Mark the walls and floors where the equipment should be mounted and holes should be drilled.
3. Fasten the brackets on both sides of the heater. Use the bracket screws, 4,2 x 9,2 mm, that came with the delivery. When mounting on the floor you fasten the bracket between the heater and its foot. See page 24.
4. Place the heater in its place.
5. Fasten the heater on the wall or on the floor. Use the bracket screw, 4,2 x 16 mm, that came with the delivery. Screws for floor mounting do not come with the delivery.

## Facts and installation measurements

Output heater (kW)	Volume sauna room (m <sup>3</sup> )	Height sauna room (mm)	Installation distances, A (mm)
4,5	3-6	1900	40
6,5	5-10	1900	150
9,0	9-14	1900	150

# Wall mounting and corner mounting

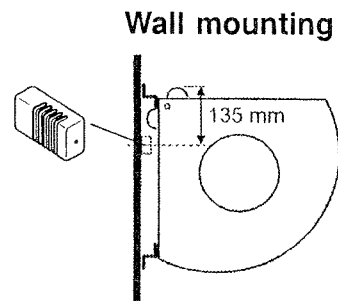
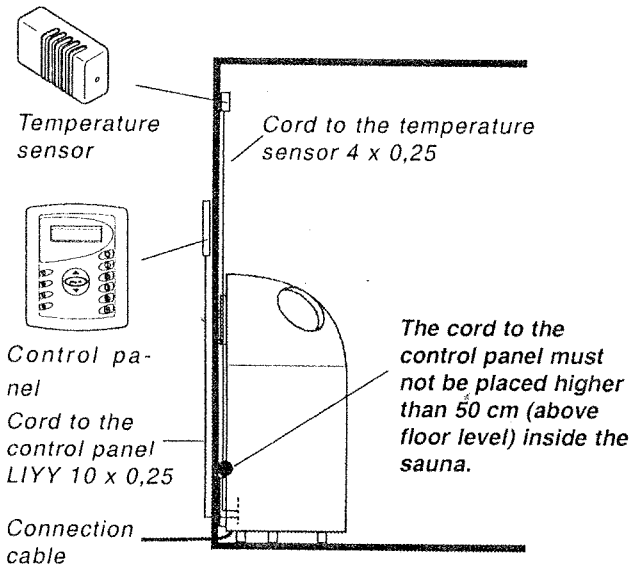
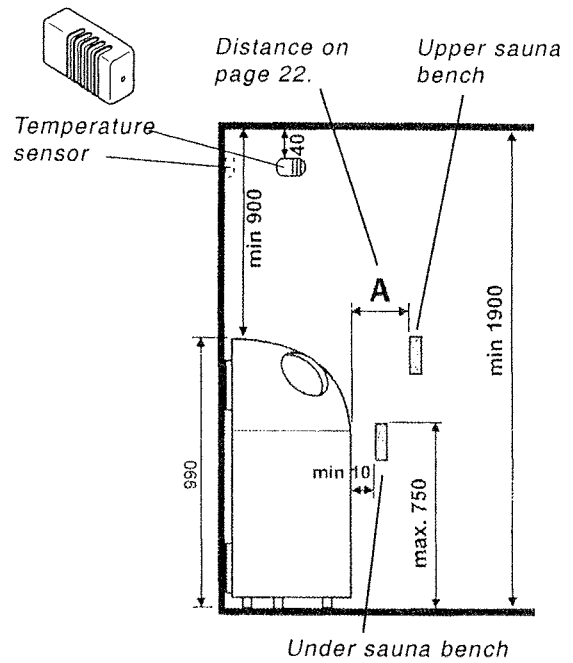
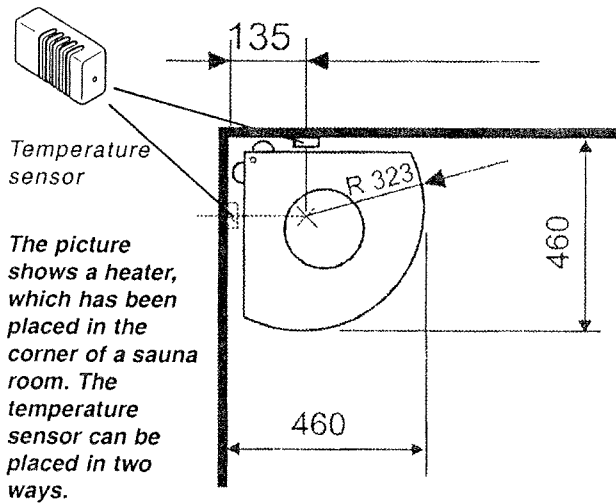

## Corner mounting

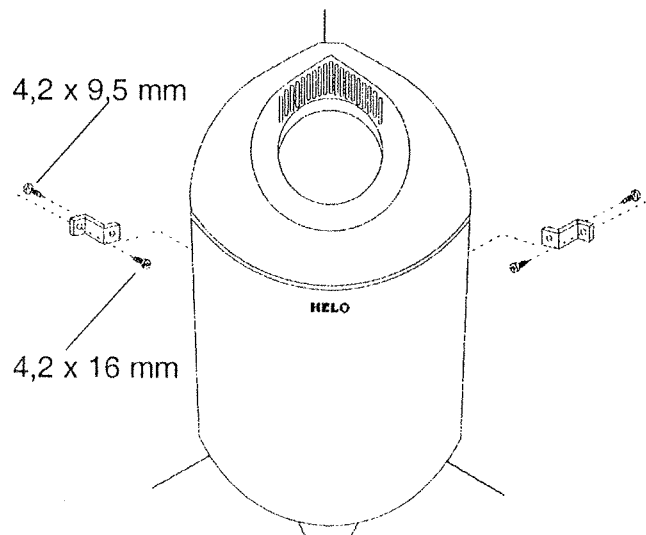
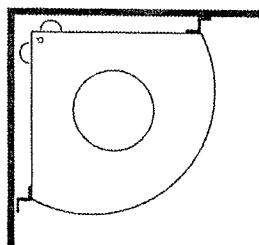

# Floor mounting

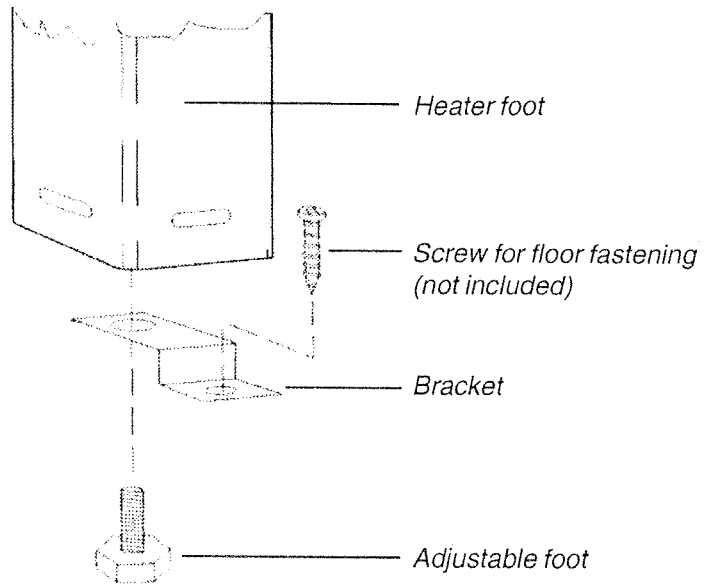
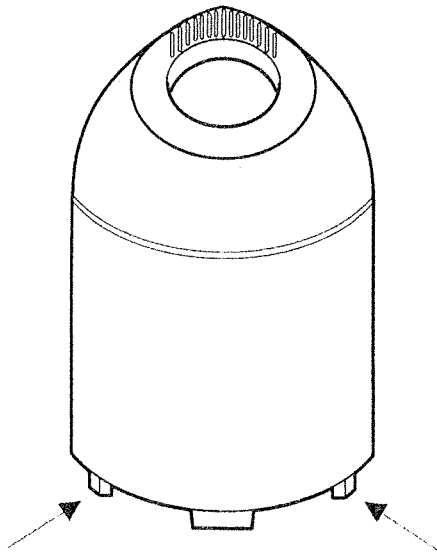

The heater shall always be fixed to the floor with the included brackets. Separate the adjustable feet and place the bracket according to the picture to the right.

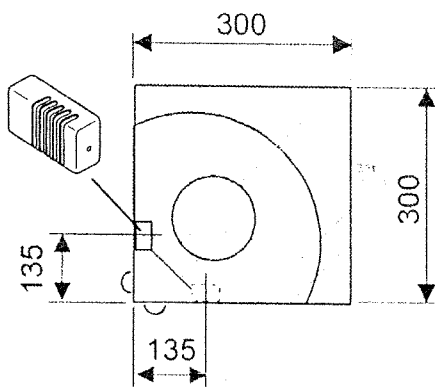
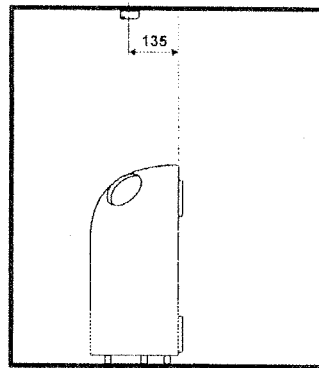
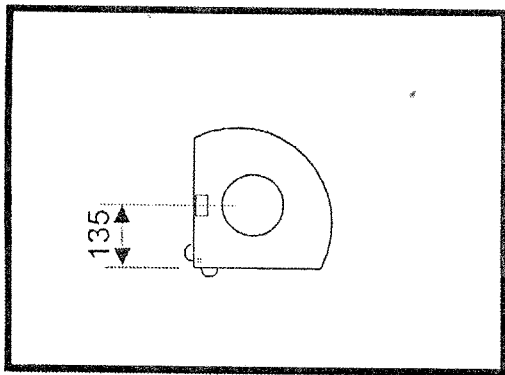

The temperature sensor shall be mounted within the dotted area in the picture.



## Mount the sensor:

1. Mark the spot on the sauna wall where the sensor should be placed. Study the illustrations on pages 23–24.
2. Open the lid of the sensor with the help of a screwdriver. See pictures 1 and 2.
3. Screw the sensor to the wall with the sheet-metal screws, 2 x 20 mm. See picture 3.
4. Close the lid of the sensor. See picture 4.

Picture 1

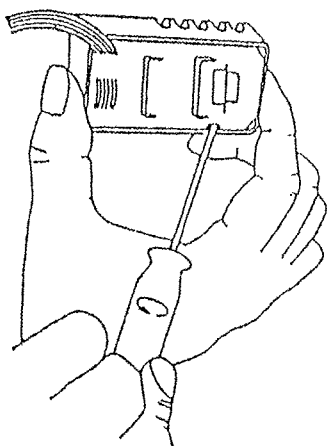

Picture 2

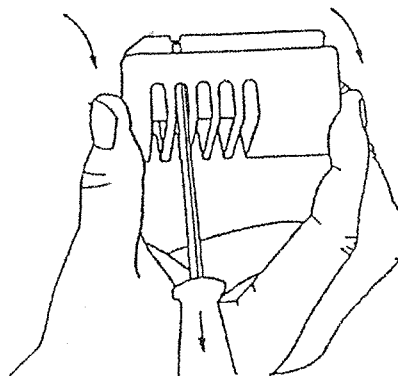

Picture 3

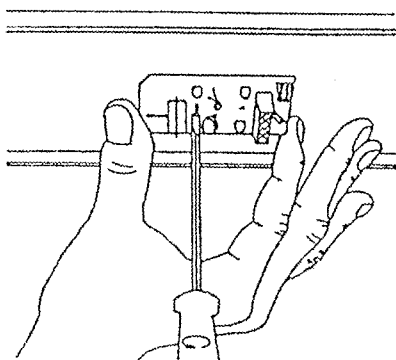

Picture 4

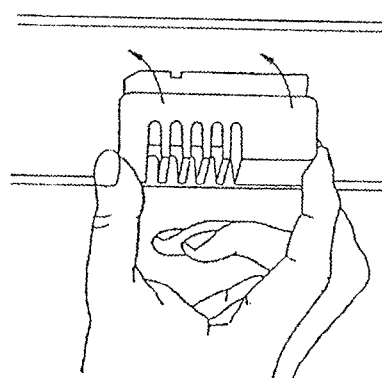

# Connect the electricity

Connecting the electricity is the most important part of the installation of a sauna heater. Only certified electricians may install the sauna heater. When the connection to the electricity network is made a standard cable HO7RN-F must be used (for example RHH or VSB).

Heating elements  
(see the dimensions on page 27)

## Connect electrical cables

### To the heater

1. Lay the heater down and unscrew the feet and screws that keep the bottom plate in place.
2. Attach the sensor cable to the socket J12. Observe the color codes on page 27.
3. Attach the sensor cable to the sockets J10 and J11. Observe the color codes on page 27.
4. Shorten the cables so that they do not reach the dotted area according to picture 1 on page 27.
5. Fasten the bottom plate and the feet and stand up the heater.
6. Connect the cables for lighting and ventilation, if needed.

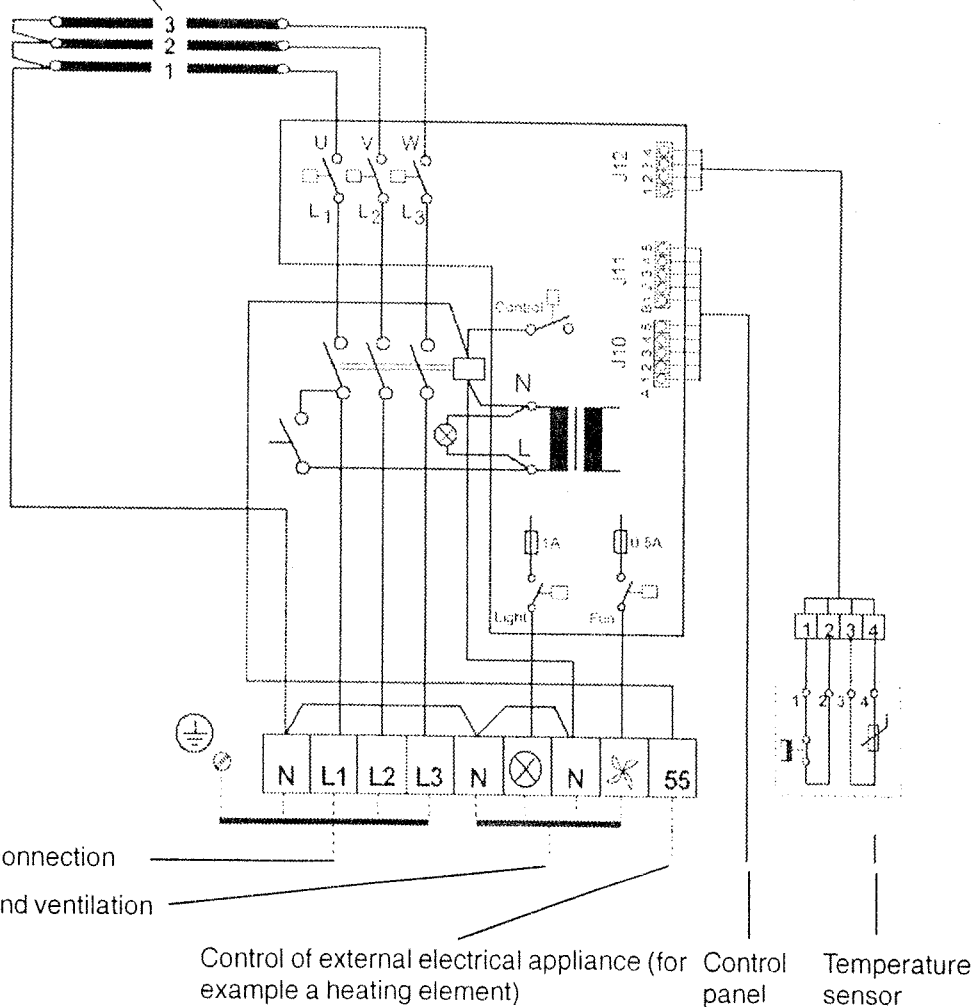

## Facts about the connection of the heater to the electric network

Output (kW)	Fuse (A)	Heater connection HO7RN-F (mm <sup>2</sup> ) (t ex RHH or VSB)	Permanent connection from fuse (mm <sup>2</sup> )
4,5	3 x 10	5 x 1,5	5 x 1,5
6,5	3 x 10	5 x 1,5	5 x 1,5
9,0	3 x 16	5 x 1,5	5 x 2,5

## Heating element

Output (kW)	Heating element (230 V) <span style="float: right;">x 3 = three elements</span>		
	SEPC 185 1500 W	SEPC 186 2170 W	SEPC 187 3000 W
4,5	x 3		
6,5		x 3	
9,0			x 3

## The heater seen from below and in cross section

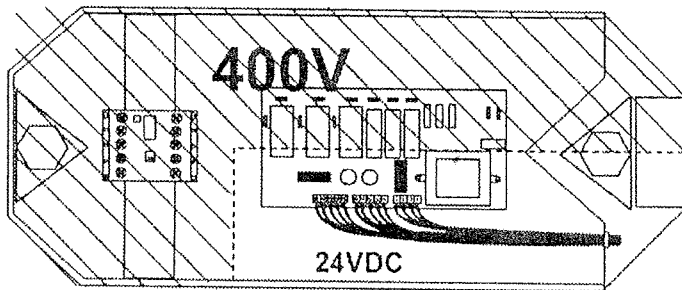

Picture 1 - The temperature sensor and the cables of the control panel may not touch the dotted area in the picture (400 V). Shorten the cables and hide them.

### Sensor cable

- |   |        |
|---|--------|
| 1 | Blue   |
| 2 | White  |
| 3 | Red    |
| 4 | Yellow |

### Control panel cable

- |    |        |    |        |
|----|--------|----|--------|
| A1 | White  | B1 | Pink   |
| A2 | Brown  | B2 | Blue   |
| A3 | Green  | B3 | Red    |
| A4 | Yellow | B4 | Black  |
| A5 | Grey   | B5 | Violet |

## Wiring diagram for control panel and temperature sensor

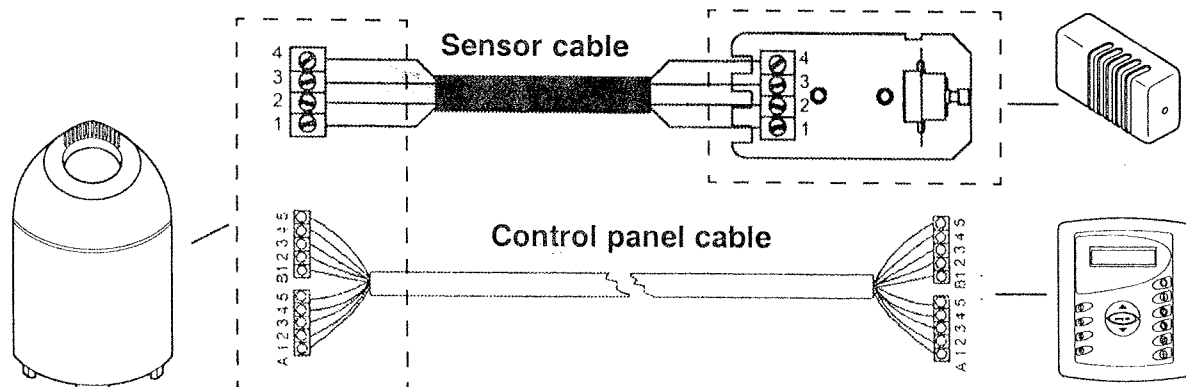

# Mount and program the control panel

The control panel has several holes in the back. These holes are used to mount the control panel outside the sauna. In order to reach the holes, the control panel must be opened using the two keys that are included. The control panel can be mounted in or on the wall. When the control panel is installed and the lid is replaced you have to set a number of basic settings on the display. The basic settings include among other things to set the time and chose the language.

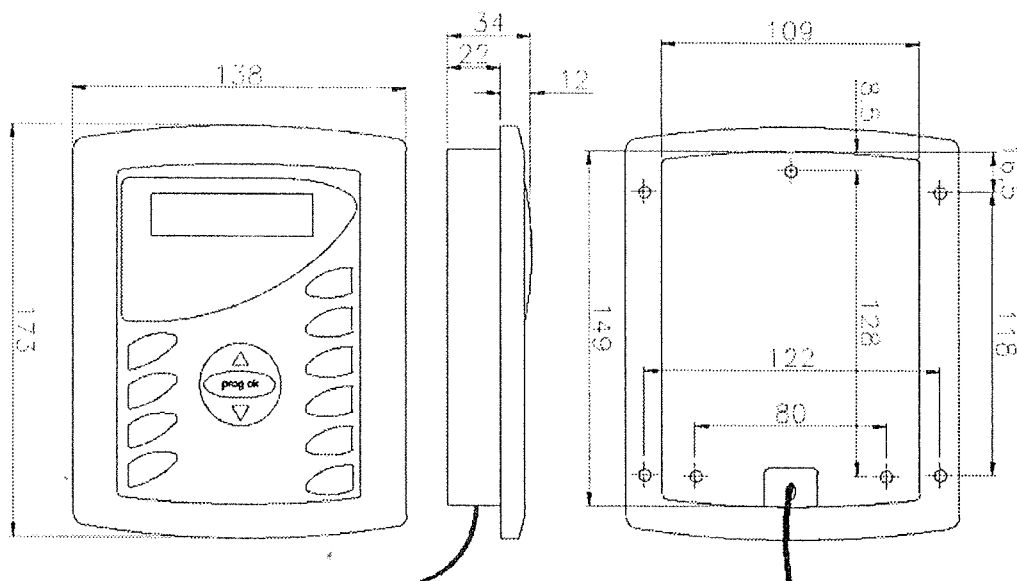

Dimensions of the control panel Digi 2002

## Mount the control panel

1. Mark on the wall where the control panel should sit
2. Use the control panel opener to open the lid.
3. Set the sheet-metal screws, 4,2 x 13 mm, in the holes and screw the control panel in place.
4. Lead the cable through the control panel so that it is placed right before the lid is put back on.
5. Put the lid back on and set the basic settings.

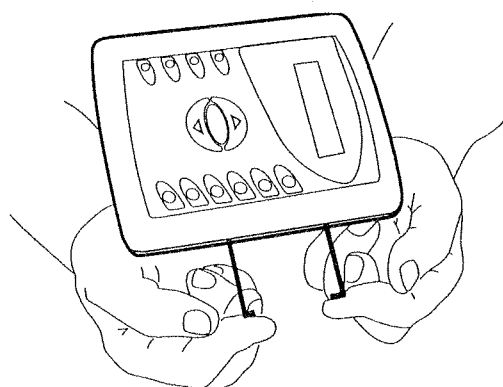

Open the lid of the control panel by inserting the control panel openers on the side.

## Program the control panel

The basic settings are to be done by the installer. They include setting the clock and choosing the language. After a power failure of more than 20 minutes the basic settings are deleted. In that case the user must reset the basic settings.

**Instructions to program the basic settings of the control panel are to be found on page 8.**

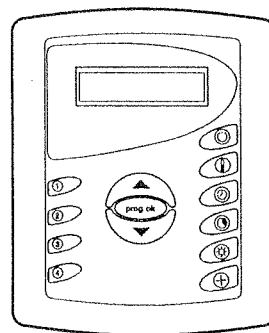

*The installer must set the basic settings. They are found at page 8.*

## Test the sauna and take safety measurements

When the installation is done and you have run through all the steps in the checklist, the only thing that remains is to test the sauna and take the safety measurements required. The object of the testing is to discover if there are any faults in material or installation.

### Check the following when testing

1. That the display of the control panel is working.
2. That all the heating elements are warming up.
3. That ventilation and lighting work when activated.

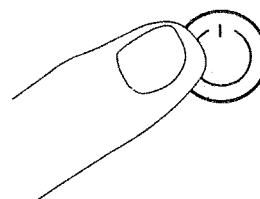

*The last step of the checklist is to test the sauna and run through the required safety measurements.*

# Helo Oy

Tehtaankatu 5-7, 11710 Riihimäki, Finland / PL 15, 10901 Hanko, Finland  
Homepage: [www.helo.fi](http://www.helo.fi) – E-mail: [info@helo.fi](mailto:info@helo.fi)

314 SKLR 9 E